

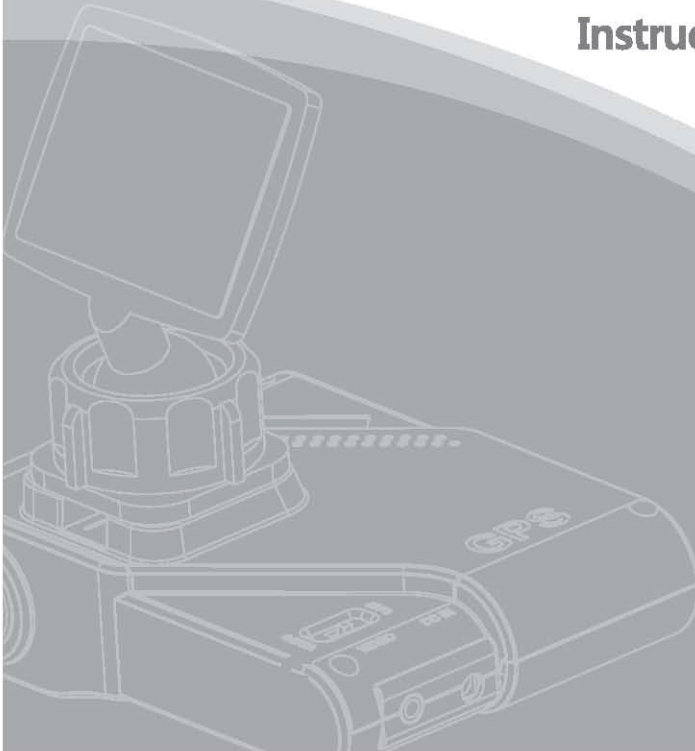

# DC-1

1 CHANNEL DRIVING VIDEO RECORDER

## Instruction Manual



\*Thank you for purchasing this product.  
For proper usage and application,  
please read these instructions thoroughly.  
\*Design and specifications are subject  
to change without notice.



# Contents

<b>Safeguard instructions</b> .....	3
<b>1. Feature</b> .....	7
<b>2. Box Contents</b> .....	7
<b>3. Installing the recorder in your vehicle</b> .....	8
1) Mounting/ Removal of the bracket .....	8
2) How to install .....	9
3) Recommended installation location .....	9
<b>4. Components and their functions</b> .....	10
<b>5. Preparations for operation</b> .....	11
1) Inserting the SD card .....	11
2) Removing the SD card .....	11
<b>6. Operation</b> .....	12
1) Power ON/OFF .....	12
2) Checking the received GPS data .....	12
3) Video recording .....	13
4) Emergency recording / Instant capture .....	14
5) Real-time video output .....	14
6) Functions of "Mode" button .....	15
7) System RESET (Restart) .....	15
<b>7. PC VIEWER MANAGER</b> .....	16
1) How to install PC VIEWER MANAGER .....	16
2) How to use PC VIEWER MANAGER .....	17
3) Configuration Set .....	21
<b>8. Firmware Update</b> .....	24
<b>9. SD Card Data</b> .....	24
<b>10. Specifications</b> .....	25
* Parking mode .....	26
* MEMO .....	28
* LIMITED WARRANTY STATEMENT .....	30



# Safeguard instructions

Please read the " Safety Rules " carefully before using this product. Following the safety rules prevents the user from injury related to the misuse of the product. It is very important to follow these safety rules. We state "Caution" and "Warning" to clarify any potential risk of damage associated with the misuse of the product.



## NOTICE

This information is for user's reference for better usability.



## CAUTION

This information is for preventing damage or shorten the life time of the products.



## WARNING

This information is for preventing bodily harm or even death.



## CAUTION



Do not drop the product.

– It may cause damage or malfunction not covered by warranty.



Do not place near magnet.

– It may cause the device to malfunction or operate erratically.



Keep the unit away from other GPS devices.

– It may cause interference of the GPS signal rate.



GPS function requires loading time when first powered on.

– It can take up to a few minutes for the device to lock on to satellite signal.



Metallic tinting and heated front windscreens can cause interruption in the GPS signal.

– If your vehicle has this then please experiment mounting the camera in different positions.



Sudden changes of brightness such as entering or exiting a tunnel or extremely dark place may cause a temporary loss in video quality.



When using the hard wiring power cable (option), you should contact to a specialty installer. ( The location of the fuse box varies depending on the car model and manufacturer. Please check the car's manual before installation)

If you leave the DC-1 powered up by connecting it to permanent live OR if your cig lighter socket remains live when the keys are out of the ignition then the camera will drain the battery on your vehicle within 5 days.



# Safeguard instructions



**The front glass and camera lens should be kept clean.**

- If it is dirty, the recording image may be low.



**Attach the product recommended place.**

- If it is installed in an obscure place, the image may be skewed.



**Do not disassemble, repair or modify.**

- It may cause malfunction and injury not covered under warranty.
- Make inquiries to your agent for repair or inspection checkup.



## WARNING



**Do not place near effective range of an air bag.**

- It may cause malfunction of air bag or accident.



**Keep clean dust on power socket.**

- A poor connection will result in malfunction.



**Install with the power off, ( After installation, connect DC jack )**

- It may cause electric shock or malfunction.



**Do not operate the product while driving.**

- It may cause an accident. Stop in a safe place to operate.



**Do not pull the power cable, remove by holding the plug and pull. Do not use a damaged cable.**

- It may cause cable malfunction, electric shock and fire.



**Do not clean exterior with alcohol, volatility or oily solvents.**

- It may cause deformation of the surface and malfunction.



**Attach the product on the front window firmly.**

- Clean the front window and fix it firmly, otherwise it may be detached due to temperature / humidity / dust / shock..



**Please read the below notice for SD cards. We do not take responsibility for data loss or damage caused by SD cards malfunctioning.**

- Clean the front window and fix it firmly, otherwise it may be detached due to temperature / humidity / dust / shock..



**Please take care below notice for SD card, we do not have responsibility for data loss or damage caused by not complying below rules.**



**Please use only authentic SC cards**

– The manufacturer do not takes no responsibility if a non-recommend card is used.



**Do not put foreign substances in to SD card slot,**

– It may cause a malfunction or SD card inserting problem.



**Do not touch the SD card with wet or oily hands,**

– It may cause malfunction due to card damage.



**Push the SD card fully.**

– If the SD card is not fully inserted then the camera cannot record data.



**Before removing the SD card, please check the power off status,**

– If you pull SD card out during power on status, it may cause malfunction or data loss,  
The DC-1 will chime after the power is removed to let you know it is safe to remove the SD Card.



**SD cards consumables, SD cards do not last forever and should be checked regularly,  
SD cards are not covered by our 2 year warranty,**



**Use a secure case for storing SD cards,**

– The data may be damaged by static while storing or moving.



**Please make sure the lock on the SD card is off,**

– If it is set to data lock , recording is not possible.



**In case of important data, please make sure you back up your SD Card,**

– The data may be lost after long term usage.



**Please check and backup the data stored on SD card and we recommend  
formatting the SD card regularly.**



**Do not disassemble or modify an SD card,**

– It may cause a serious damage to the SD card.



**Do not drop the SD card.,**

– It may cause a serious damage to the SD card.  
– This product supports up to 32GB, SDHC memory cards. We recommend using at least class 4 cards, Do NOT buy cheap memory cards...they do not last very long!



**Please take note the info below for the built-in battery**



The built-in battery is for auxiliary usage for safe saving recorded images while the power is not supplied.  
Please connect and use main power supply for normal recording.



The internal battery is a consumable , so the recording time may be reduced after 6 months.  
(The life time is different depending on user conditions.)  
– If you find the last recording is not saved continuously, the battery life may be at an end.  
Please inquire at the after sales service center or dealer for battery replacement.



**If the unit is not used for a very long time, the battery may leak,**  
– If the leakage makes contact with skin, please wash it with running water.

# 1 Feature

- Records video on a constant loop.
- Parking mode function: (Accessory power cable required)
- Wide angle of view (125°) built-in 1.5m pixel WDR Camera (wide dynamic range)
- Audio recording.
- Speaker alert
- Built-in GPS antenna.
- Built-in 3G Sensor (FRONT/REAR, LEFT/RIGHT, UP/DOWN shock sensing and recording)
- SD CARD up to 32gb SDHC
- Emergency battery equipped.
- Supports DC 12V-24V

# 2 Box Contents

\* Before using this product, please check below contents.  
If there are any missing parts, please contact your sales agent.

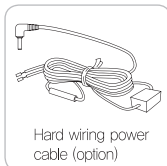
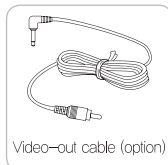
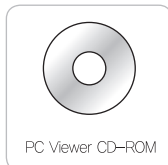
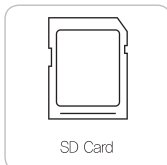
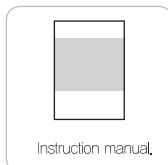

## 3 Installing the DC-1 camera in your vehicle.



### Prior to installation, check the following.

- To ensure safe installation, always perform installation in a well-lit area.
- Before installation, always turn off the engine and remove the key from the ignition.
- Do not use any other cables other than the power cable included.
- The glass to be equipped with the camera should be clean.
- For vehicles with excessive window tinting, the recorded images may appear dark.



### Ensure the mount is firmly fixed to the screen and the camera is secured tightly to the window mount. Make sure it is done up nice and tight.

## 1 Mounting of the adhesive mount.

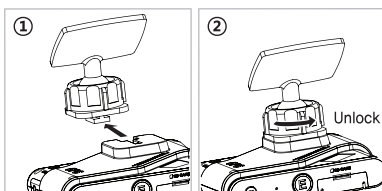
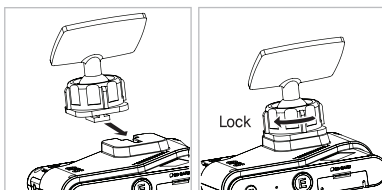

1. Make absolutely sure you know where you want to mount the camera before fixing the adhesive mount to the screen. Once the mount has been stuck in place they are difficult to removed and cannot be used more than once without replacing the 3M sticky pad.
2. Clean the glass before applying the adhesive pad. Grease or dirt will affect the ability of the pad to stick to the window.
3. Apply the adhesive mount to the screen and push hard for about 10 seconds.
4. Ideally, leave the mount to bond for about 1 hour before attaching the camera.
5. Make sure the camera is horizontal as shown in the diagram.



## 2 How to install

**Car**

**Bus or Truck**

1. As shown in the above figure, position it so that it does not obstruct your front view and at the same time, lens viewing angle does not overlap the tinting section.
2. Once it has been completely installed, keep it horizontal as shown in the left figure. Otherwise, normal images may not be obtained during recording.

## 3 Recommended installation location

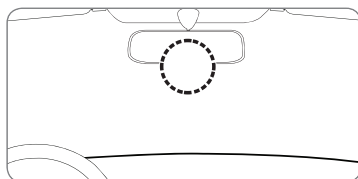

Try to install the DC-1 in the center of the screen behind the rearview mirror.



If it is difficult to install as per the diagram then it can be installed just to the left or right of the rear view mirror.

## 4 Components and their functions

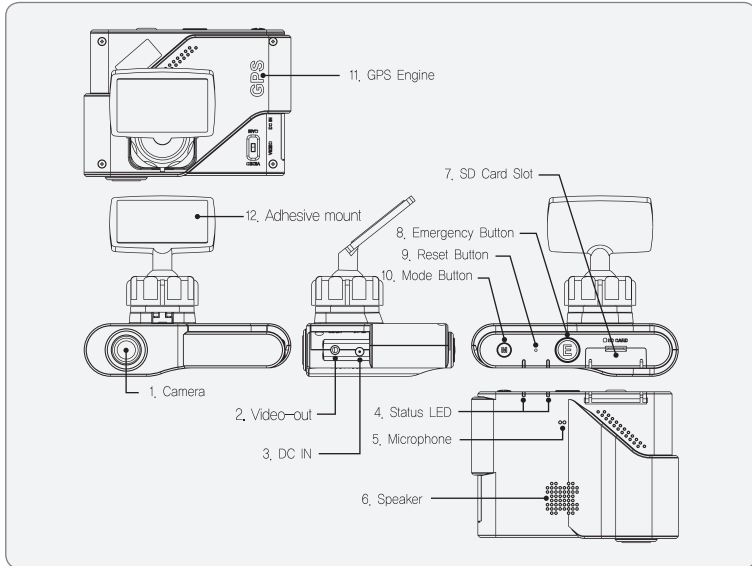

- |                     |   |
|---------------------|---|
| 1. Camera           | 1,5m pixel Wide Dynamic Range Camera,               |
| 2. Video-out        | video output port,                                  |
| 3. DC IN            | Power input (DC12~24V)                              |
| 4. Status LED       | Record / GPS status indicator LED                   |
| 5. Microphone       | Built-in microphone                                 |
| 6. Speaker          | Output Speaker for auditory warning signals (MONO)  |
| 7. SD Card Slot     | For SD cards up to 32gb in size,                    |
| 8. Emergency Button | For emergency recording and instant capture         |
| 9. Reset Button     | System reset button                                 |
| 10. Mode Button     | Audio recording ON/OFF, Parking mode ON/OFF         |
| 11. GPS Engine      | internal GPS engine and antenna,                    |
| 12. Adhesive mount  | Mount for glass window (Double-sided adhesive tape) |

## 5 Preparations for operation



**Before using the SD card, check the following :**

- The SD card can be inserted regardless of the power ON/OFF status of the product, As soon as it is inserted, it will reset the internal software and then start recording.
- To remove the SD card, first turn off the vehicle engine, and check that the LED lights go out (Not more than 20sec, required) then, remove the SD card. If the SD card is removed before the LEDs go out then the data will be corrupt and you will not be able to see the last video saved.

### 1 Inserting the SD card

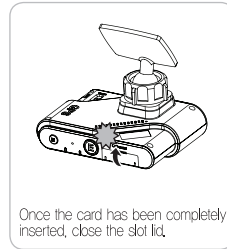
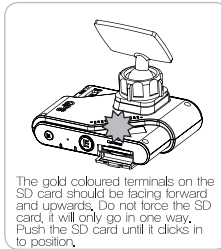
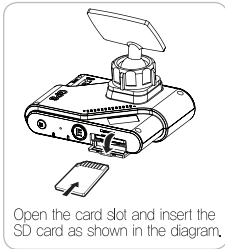

### 2 Removing the SD card

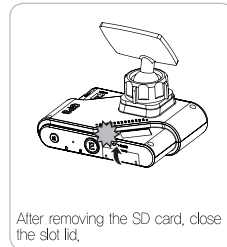
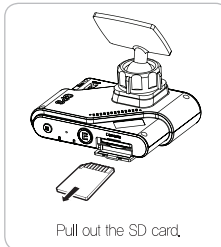
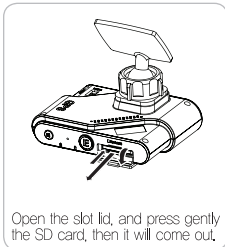

**Be sure that the SD Card direction and SD Card is inserted correctly to the product. Otherwise this will make an error.**

## 6 Operation



**Before operating this product, please take case below point.**

- Do not operate on driving.
- Recording is possible when SD card is inserted.
- If remove SD card while recording, some part of image might be deleted,(with beep sound)

## 1 Power ON / OFF

1. This product has no power on/off button. To power on, plug the power cable in to your vehicle's power socket and turn on the ignition. The camera will chime once it is ready to start recording.
2. **PLEASE NOTE** : Some vehicles have accessory sockets that are always LIVE even when the ignition is OFF. In this case the DC-1 should be unplugged at the end of the journey or it will continue to record whilst not driving.
  - ★ while recording function finishes, it is powered by the batteries built-in, after recording function finishes. The file is securely saved followed by power off. The LED lights go off and the DC-1 will chime to let you know it is fully off.



**the product does not power off by itself if using the (optional) hard wiring kit.**

## 2 Checking the received GPS data

After inserting the SD card, start up the vehicle's engine. The DC-1 will power on. At the same time, while auditory signals are heard, it will start searching GPS signals. The DC-1 will chime once it has located a satellite signal and the GPS LED will light GREEN. If the GPS LED is red then the camera is not recording GPS data.

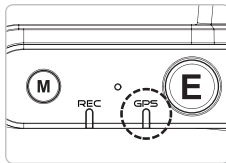

GPS functions can be used to estimate the user's driving route, speed, time and distance.

- Within the GPS coverage : Green GPS LED will light up.
- Out of the GPS coverage : Red GPS LED will light up.

### 3 Video recording

Once installation and wiring procedures have been completed, start up the engine with the SD card inserted. Then, it will power on without any other additional operation, and recording will start simultaneously.

\* Factory Default : INFINITE MODE + EVENT MODE (User can change recording mode on Recording setting / refer to page 21)

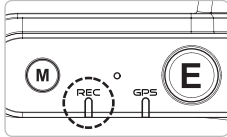

Depending on recording mode, REC LED blinks,

- Infinite recording : It blinks very shortly at intervals of 1 second,  
 - Voice recording ON(Green LED) / Voice recording OFF(Yellow LED)
- Event recording : It blinks five times per 1 second,(Red LED)

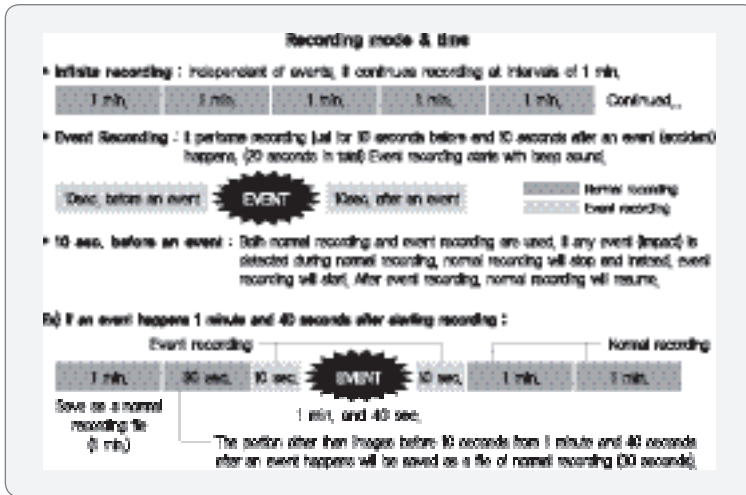

\* The words, 'an event happens' mean to detect any impact when it is given. The higher is the sensitivity, finer shocks or impacts are detected. On the other hand, the lower is the sensitivity, simply strong shocks or impacts only are detected. It is possible to adjust the intensity of detection (sensing) in the PC VIEWER MANAGER,(refer to page 21)

When the recording image is over SD card capacity, it deletes image orderly from the oldest one. And normal and event recording rate is allocated 75:25 from SD card capacity.

Ex) In case of 2GB SD card

Recording mode	Saving folder	Maximum storage
Infinite recording	INFINITE	About 1,5GB (If it is over 1,5GB, it deletes image orderly from oldest one and record new one.)
Event recording	EVENT	About 0,5GB (If it is over 0,5GB, it deletes image orderly from oldest one and record new one.)

## 6 Operation

### 4 Emergency recording / Instant capture

#### ● Emergency recording

The user can press the emergency button to trigger an event manually.

This is useful if you want to store video to view at a later date even if there has not been an impact.

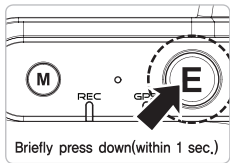

- briefly press down (E) button during operation to trigger a manual EVENT.
- recording procedures are same as those for EVENT recording, ( 10seconds before/10seconds after pushing the button)

The DC-1 also has the ability to take still photos, Photos will be stored in the "Capture" folder on the memory card.

#### ● Instant capture

Instant capture function is intended to photograph and save the front view in an unexpected event or when it is necessary to save the taken photographs at discretion. Such photographs will be saved in [CAPTURE] folder of the SD card.

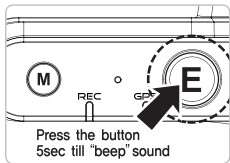

Press and hold down (E) Button during operation (5sec). You will hear a shutter sound and the image is saved as JPEG file format.(\*.jpg) If your vehicle is moving at speed or at night the quality of photos taken may be poor.

- \* This function will be disabled during event recording.

### 5 Real time video output.

If a Video-OUT cable (optional) is used to connect the DC-1 to a monitor then you can view the image from the camera in real time.

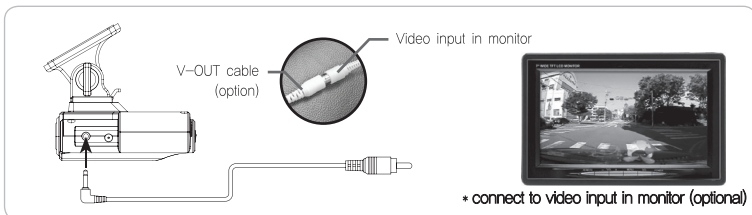

- \* Always use the included cable only. If any other cable is used, it may cause damage to the camera. Roadhawk can supply 7" TFT screens that will work with this DC-1 camera.

## 6 Functions of Mode button

- Voice recording ON/OFF (Default : ON)

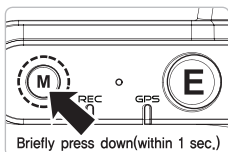

· A short press of the M button will disable audio recording until the camera is next powered down.

- \* Voice recording ON : REC LED color green
- \* Voice recording OFF : REC LED color yellow

- Parking mode: Hard wiring power cable(optional) required.

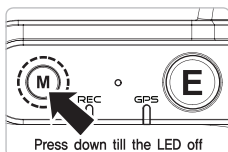

· To enter parking mode:  
Press(M) button until the LED blinks once.

- \* Parking mode ON: REC/GPS LED flash alternately
- \* Parking mode OFF: REC/GPS LED stops flashing.

1. In parking mode the camera records QVGA(320X240)
2. There is no EVENT recording, it will record in a constant loop in 3 minute segments.
3. In the parking mode, If a vehicle moves it will switch back to normal recording mode.
4. G-Force data and GPS data are not recorded in parking mode.



If it is not set to the parking mode, then the infinite recording starts when a vehicle is parked. In this case, the recording time could be shorten, So the parking mode is recommended.

## 7 System RESET (Restart)

System reset function is used in the event of any fault(s) during operation or if the DC-1 stops functioning correctly. In most cases this will not be required. If the DC-1 requires regular resetting then please format your memory card.

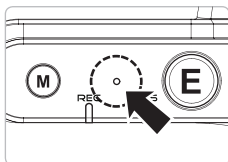

Using a thin object(e.g. paper clip), press down the RESET button for 10 seconds.

# 7 PC VIEWER MANAGER

## I How to install PC VIEWER MANAGER

### ● Recommended PC specification for PC VIEWER MANAGER

- CPU : Pentium 4 2,0GHz or more
- OS : WINDOW 98/ME/2000/XP/VISTA/WINDOW7
- VIDEO : Geforce 4 or more
- Memory : 1GB RAM or more
- HDD : 1GB or more supported

### ● PC Viewer Program Installation

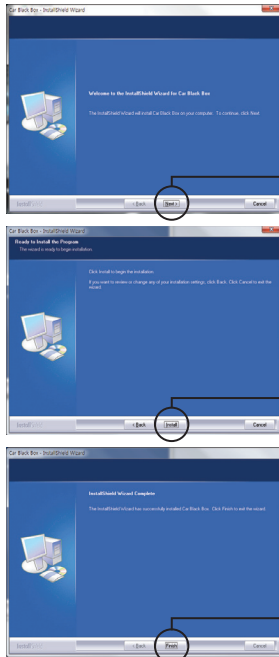

Insert CD provided into your PC and click **"NEXT"** when the setup Wizard start image pops up.

Click **"INSTALL"** button to install the Program when the image pops up.

When the installation is completed, click **"FINISH"** button to finish the process.



## 2 How to execute PC VIEWER MANAGER

- Double Click on  icon to run PC Viewer program,





Viewer program main screen









1 Playback Display	shows recording data,
2 3G-sensor / Playback Location	shows 3G-sensor data with graphs and playback location,
3 Volume Control	controls the play volume (Mute / Volume +,-)
4 Playback Control	Stop / Previous file / Rewind / Play (Pause) / Forward / Next file
5 Playback List	shows the playback list in the SD Card,
6 Playback List Extension	shows separate playback list,
7 Map Information	The driving routes are shown through this map (Google map),
8 GPS Information	The GPS location data is shown on this map. (Date/Time/Speed/Location/Direction)
9 File management	File open/save/delete
10 Configuration Set	Press this to change the configuration of the camera,
11 Program Information	It shows the current program version information,
12 Program Exit/Minimization	Exit the PC Viewer program or Minimize the PC Viewer program,

# 7 PC VIEWER MANAGER

## ● Menu Button and Control

Button	Function	Description
	Volume Control	Controls the playback volume.
	Play / Pause	Play or pause the current file.
	Previous / Next	Play the previous file or next file in the list.
	Rewind / Forward	Fast wind the video file currently being played.
	Playback Speed Control	Controls the play by Dragging bar, mute set or cancel by speaker button.

## ● Playback List Button

Button	Function	Description
	All Files	shows all files in the List.
	Infinite Files	shows normal files only in the List.
	Event Files	shows event files only in the list.
	Open Folder	Selects the folder to play.
	File export	Save the selected file to hard disk drive.
	File delete	Deletes the selected file on SD Card.

### 1. Open Folder

- 1) Clicks on  button.
- 2) When the explorer window appears, select the video files.
- 3) You can select one file or all files(CTRL+A)

### 2. File Export (Save to hard disk drive)

- 1) Select the files you want to save to hard disk drive,(Multiple selection)
- 2) Click the  button, then, (DVR Back up) folder will be auto-created in the "My documents" folder of your PC.  
The file you want is saved in (DVR Back up) folder.



File is saved straightly.

When the file saved correctly, appears this message.  
(Disappear after 1 second)

### 3. File Delete

- 1) There is a radial select button in front of each file.
- 2) When the select button is clicked, the file will be selected.
- 3) When the select button on top is clicked, all of the files will be selected. (multiple files)
- 4) Select the files you want to delete.
- 5) Click the  button, and the selected files will be deleted from the SD Card.

\*\* caution : Deleted files cannot be recovered.



When the file is deleted, appears this message,  
(Disappear after 1 second)

### • Playback List

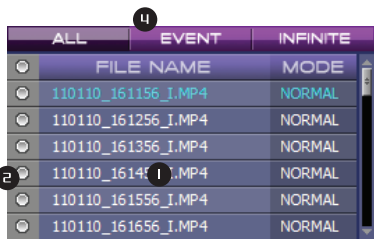

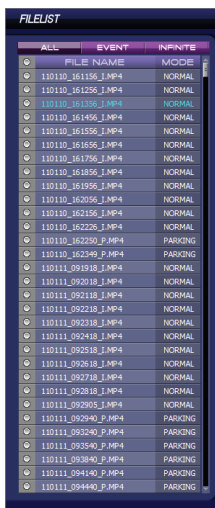

Function	Description
1 File List	shows the file in the SD Card.
2 File Select	shows separate playback list.
3 Playback List Extension	shows separate playback list.
4 File Arrangement	Arrange files by ALL / EVENT / INFINITE





- 1) Files can be arranged by ALL / EVENT / INFINITE.
- 2) When [ALL] is clicked, every file is appeared on the SD Card.
- 3) When [EVENT] is clicked, only event file is appeared on the SD Card.
- 4) When [INFINITE] is clicked, only normal file is appeared on the SD Card.
- 5) Clicks the [Playback List Extension] button, then more files can be seen all at once. (No.3 Picture)
- 6) A separated playback list is shown when the playback list extended.

# 7 PC VIEWER MANAGER

## • Other Buttons

Button	Function	Description
	Configuration Set	Configure the camera settings
	Program information	shows the current program version information.
	Minimize/Close Window	Exit the PC Viewer program or Minimize the PC Viewer program

## • Google Map Button

Control Button	Function
	Map Tracking ※ Google Map can be displayed when user PC is connected through internet
	Map Zoom In / Out

### 3 Configuration Set

- Configuration Set button , the below configuration image will pop up.

#### ※ Recording Setting



Function	Description
1 Menu	Select recording menu, time and user info.
2 Video Quality	Set up the video quality.
3 Recording Mode	Select the recording mode.
4 3G-Sensor	Select the sensitivity of 3G-sensor.
5 Default	Reset all settings back to default.
6 OK	Save the setting.
7 CANCEL	Cancel the setting. (Close)

- INFINITE MODE : Sets the DC-1 to record video on a constant loop ONLY.
- INFINITE MODE + EVENT MODE : Sets the DC-1 to record on a constant loop and creates EVENTS if the unit detects impact.

# 7 PC VIEWER MANAGER

## • Time and Unit setting



Function	Description
1 Speed Unit	Select the speed unit (kmh / mph / knots)
2 Time Setting	Set up the current date and time.
3 Standard time	Select the standard time zone.
4 Time Option	Apply "Time Setting" to RTC
5 Daylight saving	Select apply daylight savingtime.



- Apply to RTC (Real time clock)
  - Change the time to the set time. ( "\_time\_inj.cfg" file generated)
  - After setting, "\_time\_inj.cfg" file is deleted automatically.
- Daylight saving (Summer time)
  - Select whether applies daylight saving or not.

● User Setting



Function	Description
1 Input User Password	You can use this function to protect the files you make from being played back without consent.
2 Input Car Number	Record the car number on the SD Card. Shows the car number registered below the file name when the file is Played.

## Firmware Update

- **DC-1 is firmware upgradeable through SD Card.**

1. Copy the target file to update, "DC-1.bin" into a root folder of SD Card.
2. Insert SD Card into DC-1 and connect the power.
3. The updating is progressed with Red LED blinking rapidly at 0,2 second interval.
4. When Update is completed, Automatically rebooting is started.
5. Disconnect the power and connect again, DC-1 is working based on the new firmware.  
Firmware update : [www.hawk-eye.co.kr](http://www.hawk-eye.co.kr)

## SD Card Data

### 1. Event Folder

- During Event Record Mode, DC-1 records for a maximum 20 seconds of video and audio and saves it in the name of "yymmdd\_hhmmss\_E.mp4" in this folder.

### 2. Infinite Folder

- During Normal Record Mode, DC-1 records video and audio and saves it in The name of "yymmdd\_hhmmss\_I.mp4" in this folder.

### 3. \_\_System.cfg

- This is the file that contains in the setup configuration for the camera.  
If you delete this file or if you format the memory card then you will have to change the settings again using the viewing software.

### 4. version.txt

- Display version information



# Specifications



Video Input Channel	1,5M Pixel CMOS CAMERA (125° Viewing Angle) / WDR CAMERA
Recording Resolution	Normal : 640x480
Recording Frame	Day : 30fps / Night : 20fps
Recording Quality	High Quality(2Mbit) / Normal Quality(1,5Mbit) / Low Quality(1,2Mbit)
Recording Memory	High = 16MB/min, Medium = 13MB/min Low = 10MB/min
Video Compression	MPEG-4
Recording Modes	INFINITE MODE / INFINITE + EVENT MODE
3G-Sensor function	Left, Right, Forwards, Backwards, Up and Down
GPS Antenna	Internal
Audio Recording	Yes
Function Button	Image Capture, Emergency, Audio ON/OFF, Parking Mode ON/OFF
Backup Battery	Yes
Power	DC 12~24V
LED Indicator	GPS and Record
Google Map Link	Yes
PC VIEWER MANAGER	Included
Operating Temperature	-10° C ~ 60° C
Storage Temperature	-20° C ~ 70° C
Dimension	98(W)x25(H)x72,3(D) mm (Body only)
Weight	74g (Body only)



## Parking mode : Ordinary power cable(option) connecting

### ● FEATURE

Parking surveillance mode means continuous recording mode when the car is parked, It is like CCTV for your car.

It supplies Ordinary power cable (Option) which has automatic block off a low voltage so that it could prevent engine starting problem due to a dead battery.

– It blocks off the power automatically when the battery voltage is lower than 12V. The recording time is varying depending battery capacity.

### ● NOTICE

1. When install ordinary power cable, should contact to a specialty store, (The place of fuse box is varying depending on each car manufacturer, Please check the car manual before installation)
2. Please use enclosed genuine ordinary power cable, Otherwise it may cause a serious problem on the product or car fir.
3. Ordinary power cable is only available for power voltage 12V.
4. To safe usage on battery, please disassemble ordinary power cable when you do not drive for a long time (over 3 days). We recommend disassemble to safe driving even though this cable contains a function for preventing battery dead.
5. The recording time is varying depending on battery capacity.
6. Do not remodel ordinary power cable.
7. We do not have any responsibility for repair, exchanging or refund by improper use.
8. We do not support exchanging or refund after unsealing except on product defective.
9. We do not have any responsibility for a damage caused by not following this notice.

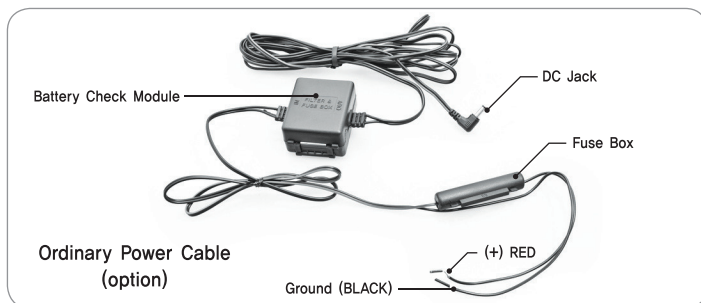

### ● Parking mode ON/OFF

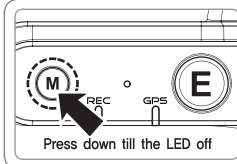

· To enter the parking mode while using the product, press [M] button till the LED lamp off and on, To exit the parking mode, then press M button shortly.

- \* Parking mode ON : REC/GPS LED alternate blinking
- \* Parking mode OFF : REC/GPS LED blinking stop

1. QVGA(320x240) recording in the parking mode
2. From the parking mode, it will change to the normal recording(no event recording), a file takes 3 minutes recording time.
3. In the parking mode, if a vehicle moves, then it will be changed to the previous recording mode, (it will take some second to minutes based on the vehicle and road status.)
4. It is not saved the 3G-sensor data and GPS information in the parking mode.



**If it is not set to the parking mode, then the normal recording starts when a vehicle is parked. In this case, the recording time could be shorten, So the parking mode is recommended.**



# MEMO



## LIMITED WARRANTY STATEMENT

**This Limited Warranty shall apply to the Roadhawk DC-1 Product including all accessories as contained within the original DC-1 box( "the Product"). Roadhawk warrants the product from its authorized distributor will meet the applicable product specifications and be free from all defects in material and workmanship for an applicable period herein( "Limited Warranty"). This Limited Warranty is subjected to the following terms and conditions :**

1. This Limited Warranty is given only to the original purchaser of the Product( "Customer" ) it shall neither exclude nor limit a) any statutory rights of the Customer or b) any of the Customer' s rights against the sellers of the Product,
2. The Limited Warranty shall be restricted to the country/region of Product purchase this is to avoid excessive import or exportation of the Product throughout the supported countries,
3. This Limited Warranty is only valid and enforceable in countries where the Product is sold, Outside of the country of purchase, any repairs performed by Roadhawk' s Authorized Service Centre are subject to charge to the purchaser at normal repair rates,
4. The Limited Warranty entitles the Customer to a Product replacement or a full refund of the purchase price for any defects relating to the performance and / or functioning of the Product which result from normal use of the Product, provided that such a defect arises within ten (10) days of the original date of purchase of the Product and cannot be otherwise repaired, Roadhawk will provide a replacement or repair of the Product at Roadhawk' s own expense for any such defect arising after ten (10) days but within two (2) month of the original date of purchase. This Limited Warranty may not be sold - on, assigned, transferred or given to any subsequent purchaser or acquirer of the Product,
5. This Limited Warranty shall last for two (2) years from the date of original purchase( "Warranty Period" ), A valid original invoice( "Proof of Purchase" ) is required,
6. This Limited Warranty covers expenses for inspecting and repairing the product during the term of the Limited Warranty, Customer shall deliver the defective Product to the Roadhawk-designated premises together with the proof of purchase, and proof of identity of the Customer, Products shipped by the Customer missing any one of these documents may render this Limited Warranty invalid, If the defect was the result of the Customer' s own mishandling of the Product, force majeure, or the result of a repair by an unauthorized service provider, the Customer shall bear all expenses relating to shipping such a defective Product,
7. Roadhawk will return the repaired Product or another Product to the Customer in good working condition, All replaced faulty Products or components thereof will become the property of Roadhawk,
8. This Limited Warranty applies only to the original hardware components of the Product and does not apply to any software or other equipment,
9. If Roadhawk repairs or replaces the Product, the repaired or replaced Product shall continue to be warranted for the remaining term of the Limited Warranty period or for three (3) months from the date of repair or replacement, whichever is longer,
10. Before returning any units for service, the Customer is solely responsible for backing up data and removing any confidential, proprietary, or personal information from the Product, Roadhawk is not responsible for damage to or loss of any programs, data, or removal storage media,
11. This Warranty does NOT cover recovery from any software updates, installation and removal of the application software, or any loss of data storage,
12. Roadhawk reserves the right to add, delete or amend the terms and conditions of this Limited Liability and any such change will be made available to the purchasers of the Product either Roadhawk' s Web site (<http://www.roadhawk.co.uk>) or by other means,

13. THIS LIMITED WARRANTY SHALL NOT APPLY IF THE DEFECT WAS CAUSED THROUGH ANY OF THE FOLLOWING:

- (a) The Product serial number, the accessory date code has been removed, erased, defaced, altered or is illegible; or
- (b) The defect is resulting from the use of the product in a manner other than their normal and customary manner, e.g. in excess of their minimum specification of operating instructions, or malfunction or failure resulting from use of uncalibrated voltages; or
- (c) Deterioration of the Product due to normal wear and tear. All plastic surfaces and other natural wear of externally exposed parts of the product are scratched or damaged under normal usage; or
- (d) The defect is arising from improper installation, unauthorized repair, alteration or modification to the Product by third parties; or
- (e) The defect is arising from operating with components or accessories (ancillary or peripheral equipment) not officially authorized or provided by Roadhawk or used in other than its intended use; or
- (f) The defect or damage are arising from unauthorized modification; or
- (g) The defect or damage is arising from misuse, mishandling, accidental loss, abuse, accident, negligence and damage caused directly or indirectly by Customer, including but not limited to improper testing, installation, alteration or modification or any kind, or spillage of food or liquid, or build up of dirt or dust, or mains supply problem, thunderstorm activities, or infestation by insects or vermin, or exposure to abnormally corrosive conditions, or operation with extreme heat or humidity; or

14. WHERE A DEFECT WAS UNDETECTABLE BY THEN-AVAILABLE TECHNOLOGY OR WAS THE RESULT OF COMPLYING WITH THE APPLICABLE REGULATORY STANDARDS OF WHERE THE DEFECT WAS THE RESULT OF THE CHANGE IN THE DESIGN OF THE PRODUCT COMPONENTS SUPPLIED BY A THIRD PARTY, MOBITECH WILL NOT BE LIABLE FOR ANY LOSSES OR DAMAGES OF ANY NATURE, INCLUDING BUT NOT LIMITED TO LOST PROFITS OR COMMERCIAL LOSS OF THE CUSTOMER.

15. This Limited Warranty does not affect the Customer's statutory rights in law specific to the country of purchase, and such rights remain protected. Some countries do not allow the exclusion or limitation of incidental or consequential loss or damage, or limitation of the implied warranties, in which case the preceding limitation of exclusions may not apply to such Customers. Please note Warranty service availability and response times may vary from country to country and may also be subject to registration requirement in the country of purchase. If you require assistance regarding warranty conditions, or have any other inquiries, please contact the Roadhawk Customer Care Center or via the official website.

Product	Warranty Period
DC-1 Car Black Box	2 years from purchase

# INSTRUCTION MANUAL